

Swift-Cut *XP*

AN **ESAB**® BRAND

CNC PLASMA CUTTING SYSTEM

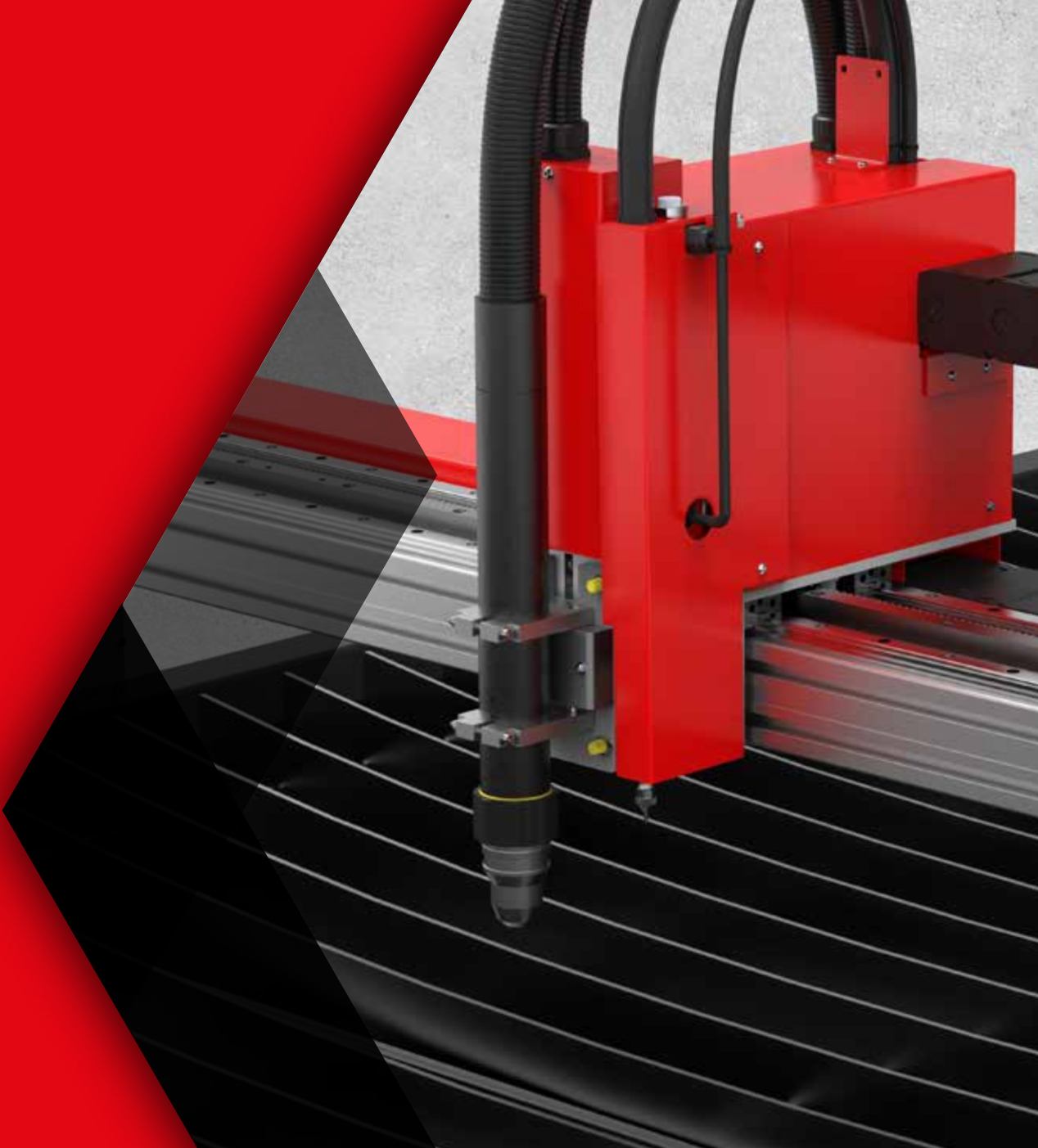

Introducing the Swift-Cut XP

The brief was simple, take all that we learnt with our best selling Swift-Cut Pro plasma machine and build it bigger, stronger and more powerful than ever before. The outcome is a range of two heavy duty CNC plasma cutting machines built to withstand the rigours of all day cutting whilst still remaining incredibly affordable.

Why choose a Swift-Cut XP?

The Swift-Cut XP is cutting edge in its design and more durable than ever. Designed with production cutting in mind up to 1 1/4"* and with an edge start capacity of up to 2", the XP range of tables is supplied with AC servo motors across all axes for improved performance and accuracy.

*in conjunction with the ESAB m2 200i cutting mild steel



The Swift-Cut XP is our heavy duty, production-ready CNC plasma cutting machine

How have we built such a durable plasma cutting machine at such an affordable price point?

Our Swift-Cut XP machine has been designed, prototyped, built, and tested by our own in-house engineering team. Nothing on this machine is ineffectual; so at the design stage, if it doesn't improve the performance, functionality and durability, then it simply won't make the cut!

TABLE BED OPTIONS
The water table bed option offers efficient fume suppression reducing the need for external fume extraction. Alternatively the zoned downdraft table option captures fumes and particulate from beneath the cutting area.

BREAKAWAY HEAD
Ensures the torch is protected in the event of a part collision.

PROTECTION COVERS
Protect key components against the harsh cutting environment.

INTELLIGENT TORCH HEIGHT CONTROL
Never have to set up torch height control yourself. Automatic voltage sampling provides repeatable cut quality and increased consumable life compared to conventional Torch Height Control systems.

ENGRAVING TOOL
The SwiftMARK engraving tool allows you to mark and cut in one operation, meaning no more outsourcing or moving your project from one machine to another (optional extra).

FLOATING INITIAL HEIGHT SENSE
Reliable touch off sensing system for accurate pierce heights.

GANTRY BEAM
Lightweight but rigid gantry beam supports twin x-axis linear rails, it also gives you the ability to cut 8" box sections.

SOFTWARE
Easy to use SwiftCAM Advanced and SwiftCNC software included as standard

ENCLOSED DRAG CHAINS
Fully enclosed drag chains protect cables against damage from molten material.

HEAVY DUTY GANTRY
Heavy duty gantry end castings with machined faces provide a precise and stable platform for the cutting head.

LINEAR RAIL
Precision linear rail on all axes combined with AC digital servos delivers exceptional positioning accuracy.

HEAVY DUTY BASE
Fully welded reinforced base provides the required support and rigidity when cutting thick material

OPERATORS CONSOLE
Ergonomic operators console with touch screen and keyboard/mouse inputs.

“
Swift-Cut tables are ruggedly built, easy to use, have great accuracy and most importantly, give an excellent cut.
”
Alan Bradford, Plasmatech

Main Key Features:

- Intelligent Torch Height Control (ITHC) means less set up and the perfect cutting height every time
- 360 degree breakaway head stops any damage to the torch or work piece in the event of a part collision
- SwiftCAM Advanced software with auto nest facility and SwiftCNC control software included as standard
- Downdraft and water table cutting bed options available throughout the range
- Designed, engineered, and fully supported by the Swift-Cut team
- Freestanding operators console can be positioned at any point around the table
- A choice of eight plasma power sources with capacities from 0.12" to 1 1/4"
- Smooth and precise AC servo motors across all axis
- Mixed gas cutting and water-cooled torch available on MAXPRO 200, m2 200i and Autocut power sources
- Water Mist Secondary (WMS) optimises non-ferrous metal cutting on m2 200i

Table Specifications & Features

The Swift-Cut XP has been designed by our skilled team of engineers to provide an all-encompassing plasma cutting solution with industry leading features as standard and is available in 2 sizes.



XP 510

5' x 10' cutting area



XP 613

6' x 13' cutting area

Table Specifications

	XP 510	XP 613
Table Footprint	12.2' x 6.6'	15.5' x 8.1'
Table weight	3300lbs	5732lbs
WT Capacity	203 US Gallons	343 US Gallons
Height	70"	
Cutting envelope	10' x 5'	13' x 6.5'
Z-Axis travel	6"	
Maximum supported material load	51lbs/sq. ft	
Traverse speed	708ipm	
Drive description	400W AC servo motors fitted with antbacklash gearboxes on the X and Y axis. 100W AC servo on ballscrew driven Z-Axis. Linear rail on all axes.	
Gantry Clearance	8.2"	
Maximum material thickness	1.25" (Mild Steel - Pierce)	
Maximum cut capacity of box section	6"	
Fume extraction method	Water table or Downdraft	
Input Voltage	230VAC (4A)	
Input Air Pressure	100-110PSI	
Flow rate	10CFM	

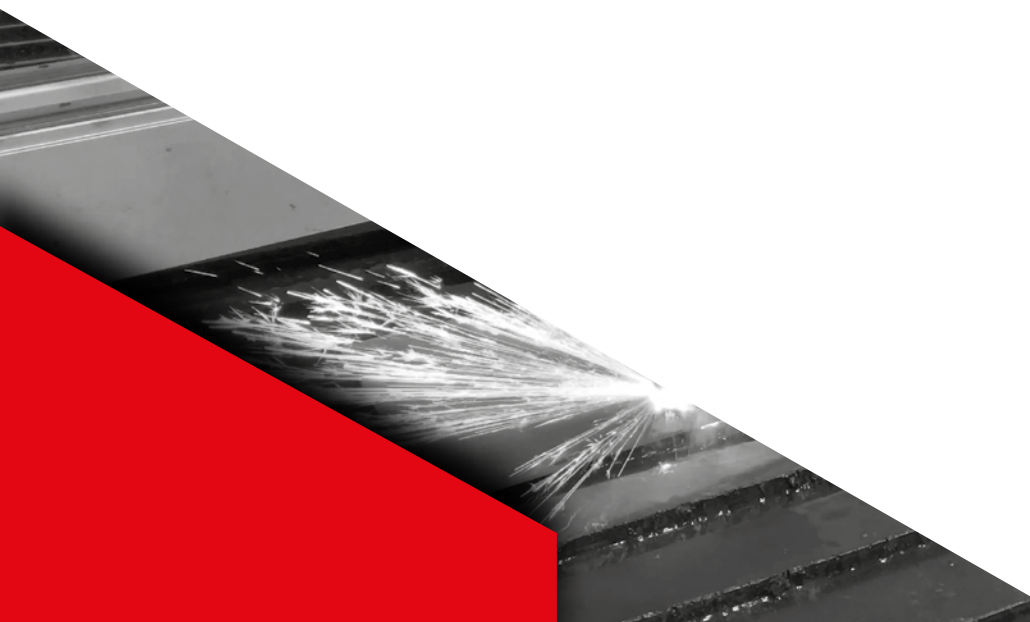

SwiftCAM Software (features)

Standard

- JPEG/DXF/DWG import capable** - Import .dxf or .dwg files or convert .jpg images for cutting
- Automatic Lead in/out** - Software automatically applies lead in/out for quicker programming
- Automatic nesting** - Automatically nests parts for economical sheet usage
- Part in part nesting** - Automatically nest parts in scrap areas to fully utilise sheet
- Advanced Drawing Importer** - Built in system to clean, scale or delete items within problematic drawings
- Parametric shape library** - 89 configurable shapes

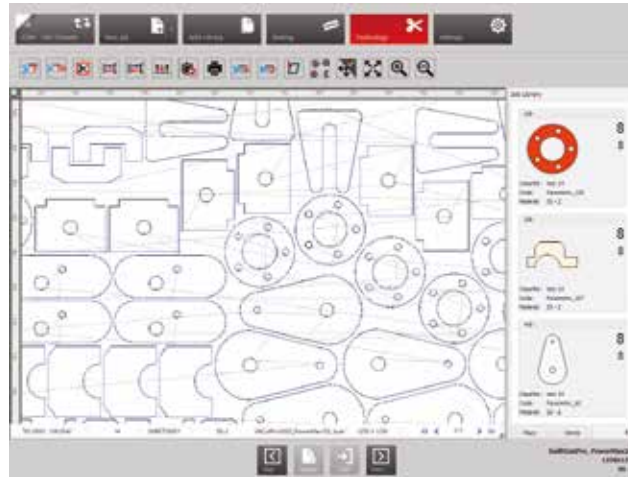

SwiftCNC Software (features)

- G-Code Browser** - Allows the user to start cutting from any individual profile within the G-code
- Cut recovery** - This function allows the user to start from any position along the cut path whilst maintaining cut accuracy and reducing material waste
- Direct Cut Control** - Remote control of settings for Hypertherm Powermax plasma systems
 - Automatic control of cutting amps
 - Automatic control of air pressure
 - Automatic control of cut mode
 - Read fault codes from the operator's console
 - Continuous arc mode - A simple unique solution allowing operators to cut wire mesh and perforated materials with the Hypertherm Powermax plasma systems
- Basic and advanced displays** - Basic view for beginners and advanced view for more experienced operators
- G-code Favourites** - Save up to 5 G-code files for quick loading
- G-Code queue** - Queue up to 5 G-Code files for quick loading

- Sheet trim** - Easily trim off scrap material. Options to go between 2 or 3 points on the material
- Sheet alignment** - Simply use the plasma shield to reference the two bottom corners of the sheet and the software will automatically adjust your part(s) or nest to the new angle. This will ensure the plasma arc will not 'run off' the material as it travels up the cutting bed
- Datum store** - Don't lose a datum point again, this system stores your last datum point so even if you lose power, you will not lose your position
- Configurable datum points** - Set up to 5 datum points anywhere on the cutting bed. This can be used to reduce setup times when using jig fixtures or to set custom parking positions
- Dry-run mode** - View the plasma torch movement, cutting order and speed in real time before you switch on the pump, so any problems are found and corrected without wasting material unnecessarily
- Touchscreen display** - Seamlessly switch between the wireless keyboard and mouse or the touchscreen display
- Graphical toolpath display** - Visual representation of where you are on the toolpath

“Ease of use was a major deciding factor. The software is very user friendly and requires little prior computer skills.”

Delmer Yomer, Wellspring Components, USA



Operator console spec

- Touchscreen HMI with wireless keyboard and mouse control
- Footprint – 23" x 23"
- Height – 56"
- Weight – 100lbs
- Operating system – Windows 10, 64 bit
- Software included – SwiftCAM, SwiftCNC
- Remote support application installed as standard

Cutting Power Options

Plasma Source: Hypertherm and ESAB

Max pierce capacity	Mild steel	Stainless steel	Aluminium	Duty cycle	100% duty cycle
Powermax 45 XP*	1/2"	3/8"	3/8"	50%	32Amps
Powermax 65 SYNC™*	5/8"	1/2"	1/2"	50%	46 Amps
Powermax 85 SYNC™*	3/4"	5/8"	5/8"	60%	66 Amps
Powermax 105 SYNC™	7/8"	3/4"	3/4"	80%	94 Amps
Powermax 125	1"	7/8"	7/8"	100%	125 Amps
MAXPRO200	1.25"	1"	1.25"	100%	200 Amps
ESAB A120*	3/4"	5/8"	5/8"	80%	100 Amps
ESAB m2 200i	1 1/4"	1 1/4"	1 1/4"	100%	200 Amps

* Single phase option available

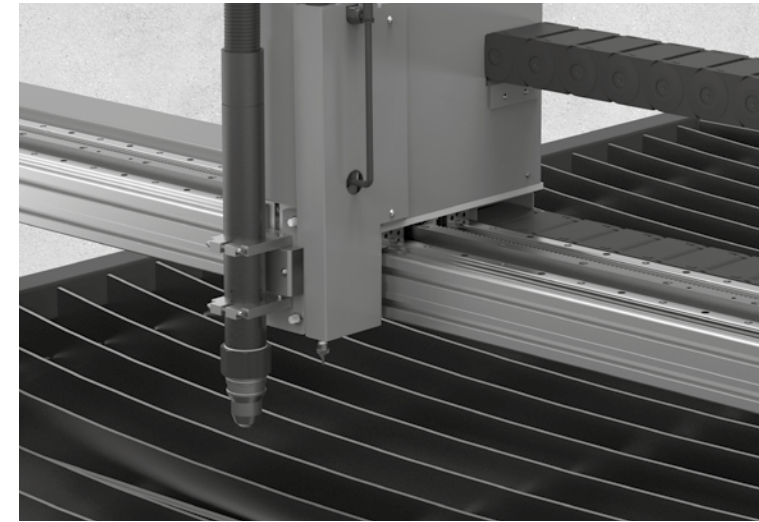

Air Spec

- Clean, dry air supply that should meet ISO8573-1 class 1.2.2.
- Input air pressure – 100-110 PSI
- Flow rate – 10 CFM

Options

- SwiftMARK engraving tool
- Zoned Downdraft (DD) or Water Table (WT)
- Powermax and ESAB consumable kits
- SwiftCAM Advanced software
- Compressor options available
- Air dryer options available
- 3 stage compressed air filtration
- Filtered extraction or extractor fan options for Downdraft machines
- Anti-rust solution
- Anti-fungal tablets
- Wireless or hardwired internet connections



Swift-Cut aftercare is second to none

We take as much pride in helping our customers after the sale as we do when we are making the sale, and every aspect of the user being able to get the absolute best from their Swift-Cut Pro has been thought about. Whether you need remote assistance, advice, or an engineer's visit, we will always make sure that you are getting the very best in aftercare.

There are a number of options to choose from when you come to decide how you wish to maintain your machine, and with over forty years combined experience in plasma and waterjet cutting, we have great knowledge when it comes to cutting on many different grades and types of material.

To enable us to support and train our global customers and sales partners, Swift-Cut has invested heavily in technology that allows us to provide remote services by using Smartphone, Tablet and Wearable Technology via collaborative software tools to train, assist and diagnose the problem with precision and in less time. The My Swift-Cut app allows us to provide real-time video support which minimises time spent on the job and keeps machine downtime to a minimum.



We offer interactive online service kits which are designed to keep your cutting table running at its best, with the minimal amount of downtime. As part of the package, our support team will dial in remotely and talk you through the service procedure, step-by-step.

In addition to the standard warranties that come with all our cutting tables, if you feel you need more, you can purchase extended warranties which can cover all aspects of support, parts or both, giving you even more peace of mind. Contact a member of our team for further details.



“

Swift-Cut has enabled us to diversify from our primary business into an area we would never have ventured into.

Leightec

”

Swift-Cutter CNC family

Here at Swift-Cut we build long-standing relationships with our customers, with many buying multiple machines from us over time.

Once you buy a Swift-Cut table, you become part of our family, we'll share what you do and let you know what other Swift-Cutters are up to.

Our social media pages are an interactive platform where we hope our customers feel at home, or check out our Swift-Cutters Case Studies page on our website for more idea of what your fellow Swift-Cutters are up to and how they get the very best from their machines.







If you require any further help or information please visit swift-cut.com/usa

Swift-Cut XP

AN ESAB® BRAND

follow us

-  @SwiftCutAutomation
-  @SwiftCutAutomationUSA
-  Swift-Cut Automation
-  Swift-Cut

For more information contact

[swift-cut.com/usa](https://www.swift-cut.com/usa)

No part of this publication may be reproduced, stored in a retrieval system, or transmitted in any form or by any other means, electronic, mechanical, photocopying or otherwise, without prior permission from Swift-Cut Automation Ltd. All references in this publication to operating weights, sizes, capacities and other performance measurements are provided for guidance only and may vary dependent upon the exact specification of machine. They should not therefore be relied upon in relation to suitability for a particular application. Guidance and advice should always be sought direct from Swift-Cut or an approved Swift-Cut partner. Swift-Cut reserves the right to change specifications without notice. Illustrations and specifications shown may include optional equipment and accessories. All images are correct at time of publication.

